

PROART

Operating Instructions



A 5030 Matrix Control Unit
A 5036 Remote Control Wallplate

Overview

Congratulations on purchasing a Proart A 5030 multi-source, multi-room audio distribution system. This system allows up to 8 audio program sources (eg tuner, CD, DVD) to be distributed to six different rooms or zones. It enables the selection of a desired source and volume setting in each room independently of other room settings via infra red re-transmission. A complete system consists of control wall plates, input matrix controller, zone amplifier and infra red (IR) transmitters.

Features

- Remote source and volume selection via wall plate or IR remote control
- Source selection and volume level display
- Up to 6 speaker zones
- Up to 8 input sources
- Wallplates can be situated up to 50m from controller
- Cat 5 cable and RJ45 connections for easy installation
- Local 3.5mm source input for MP3 players etc.
- Wall plates fit standard electrical wall box
- Easy to install and configure
- Multiple wall plates per zone
- 3 external contact switch outputs
- Priority input
- IR repeaters for external source control (CD, tuner, DVD)

Installation

1. Connect the wallplates using figures 2 & 3 as a guide. Figure 3 must be used if more than 1 wallplate is used per zone.

The wall plates will fit into a standard single gang electrical wall box. Connect the RJ45 plug and cable to either of the sockets on the rear of the wall plate, with the connecting cable wired pin 1 – pin 1, pin 2 – pin 2 etc, for all 8 pins.

2. Each wallplate used in the system must be assigned a zone number. To assign a zone number turn the rotary switch on the rear of the wall plate (figure 1) to one of the settings listed below:

- Zone 1** – rotary switch set to no. 1
- Zone 2** – rotary switch set to no. 2
- Zone 3** – rotary switch set to no. 3
- Zone 4** – rotary switch set to no. 4
- Zone 5** – rotary switch set to no. 5
- Zone 7** – rotary switch set to no. 7
- Zone 8** – rotary switch set to no. 8

Switch settings 9 and A to F are not used.

If you wish to have multiple wallplates controlling the same zone, ensure all rotary switches for that zone are set to the same position.

Figure 1: Wall plate rear detail.

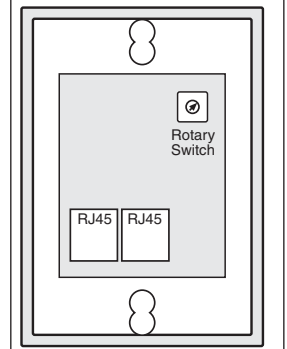

Proart Multizone Audio Distribution System

3. Connect input sources to RCA inputs (see fig 2 to 3). This can be any line level RCA audio source ie: CD, DVD, Set top box, Tuner etc.
4. If you wish to utilise the local source inputs available on the A 5036 wallplate, you must relay the signal from the "source output" RCA's on the rear panel to the "source input" RCA's. See figure 5 for example.
5. Connect IR emitter to emitter outputs. Where more than 3 sources are to be controlled we suggest the use of either:
 - a) Blaster type emitters (such as the Altronics A 1052, A 1053, A 1077 and A 1080). These can be located up to 20cm from equipment to control more than 1 input source.
 - b) Dual emitters (such as A 1053 and A 1080).All IR emitters are available separately. Figure 4 shows a typical IR emitter setup.
6. Connect the IR input if required. This is for use in an area where a keypad is not used and a remote control will be used to control input sources. Use the A 1075A IR target available separately.
7. Connect optional priority switch contacts if required. This is a switch contact which will activate source 8 on all outputs. This could be used to mute music when a doorbell or phone rings.
8. Additional switching options. The switch contacts 1-3 can be used to control lighting, curtains, projector screens, feature waterfalls etc.
9. RCA line level outputs are provided for connection to amplifier(s) inputs if required.
10. Before switching on, ensure the voltage selection switch is set to 220-240V.

Connecting To 12 Channel Amp (Altronics Model: A 5024)

The A 5030 can be used as a standalone source switcher, or alternatively used with the A 5024 12 Channel amplifier. This permits zone amplification for up to 12 mono channels or 6 stereo channels. Or a combination of both. Each channel can be configured to accept either a dedicated, or common input source.

For a majority of installations dedicated source inputs will be used. This allows each zone to be playing a different source simultaneously. It also allows local source input from the wallplates. See figure 6 for details on how this is set up.

NOTE: If you wish to use local zone source input on the wallplates, YOU MUST connect the A 5030 to the A 5024 in this configuration.

The common source input (or BUSS) on the A 5024 is best used when connected to a home theatre receiver. This allows you to quickly change audio sources across multiple zones at once.

Connecting A Doorbell

The A 5030 can be connected to your doorbell circuit to provide muting of activated zones and/or playback of a chime over the speakers. To use this function connect wires from the closing contacts of your doorbell to the screw terminals on the rear panel of the A 5030 labelled "BUTTON" (see figure 7).

A trigger terminal is also provided if you are sending a low voltage (5-24V DC) doorbell signal from other home automation equipment.

Three doorbell sounds are provided. Bell 1 is a common "ding dong" sound. Bell 2 is a chime sound. Bell 3 is a melody sound. Factory default is Bell 1.

Doorbell level can be adjusted via the rear panel volume control. The doorbell sound level will vary in each zone according to the volume level set. Doorbell sound will not work in zones where keypads are switched off or muted.

If you prefer sources to be muted when the doorbell is activated so you can hear your existing door chime, set the doorbell volume level to minimum.

Data Link Port

The data link is for connecting more than 1 controller together. Please refer to the A 5030 instruction addendum for full connection information.

Operation

Switch on the power switch. The blue indicator will illuminate. The power switch can remain permanently on. Note: the unit will not retain volume and input source settings when mains power is turned off.

Zones can be turned on or off with the remote control "power" button or via the wallplate mute/power switch. The "status" indicator on the main control unit will illuminate to show which zones are on.

The wall plates re-transmit the remote control signal for most input sources (such as CD player / tuner etc) to change music tracks / radio stations etc. The "IR" indicators will flash when any remote control is used to show the signal is being transmitted. When the wall plate switches are used the "RX/TX" indicator will flash to show the wallplate is being used.

These wall plates will vary volume levels from 0-99. We suggest you set your amplifier volume controls to maximum required volume level for each zone. This can protect speakers from overdriving when wall plates are inadvertently set to high volumes.

Your controller is now ready to use.

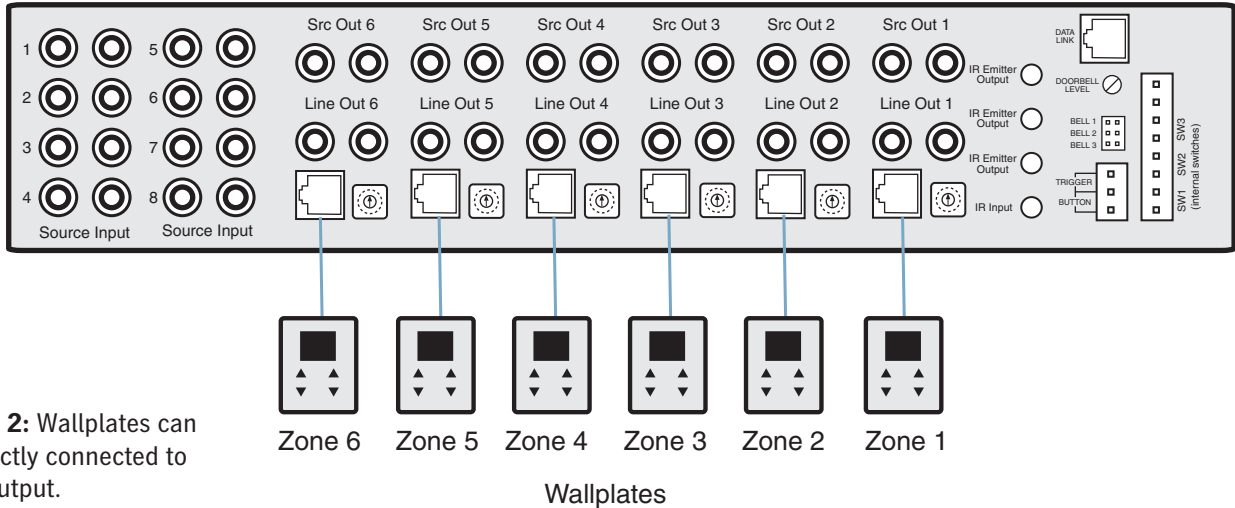

Figure 2: Wallplates can be directly connected to each output.

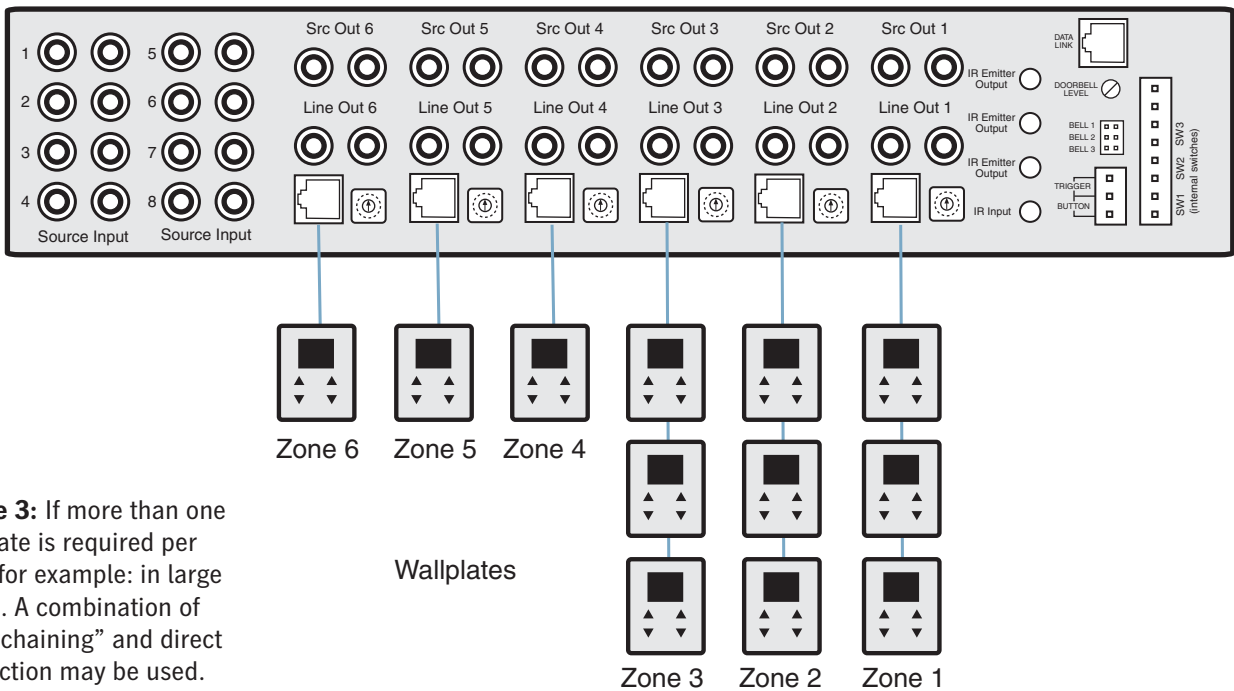

Figure 3: If more than one wallplate is required per zone, for example: in large rooms. A combination of “daisy chaining” and direct connection may be used.

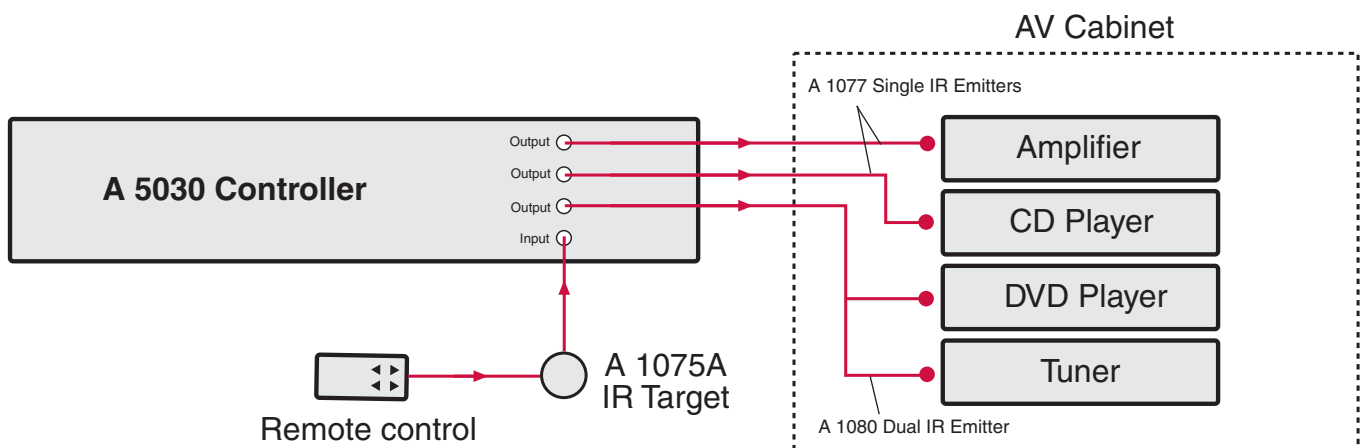

Figure 4: A typical infra red emitter installation showing signal flow from IR target to AV equipment.
NOTE: Accessories not supplied with controller.

Proart Multizone Audio Distribution System

Figure 5: If you wish to use the local 3.5mm source input on the zone wallplate, you must connect an RCA lead from the zone source output to the source input. In this example, zones 1 and 5 have the 3.5mm input available for an MP3 player etc.

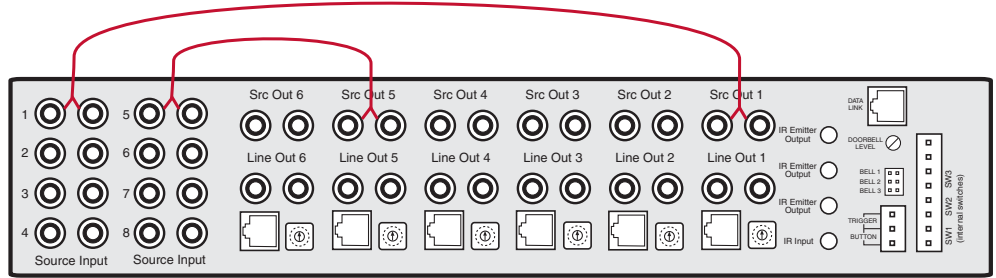
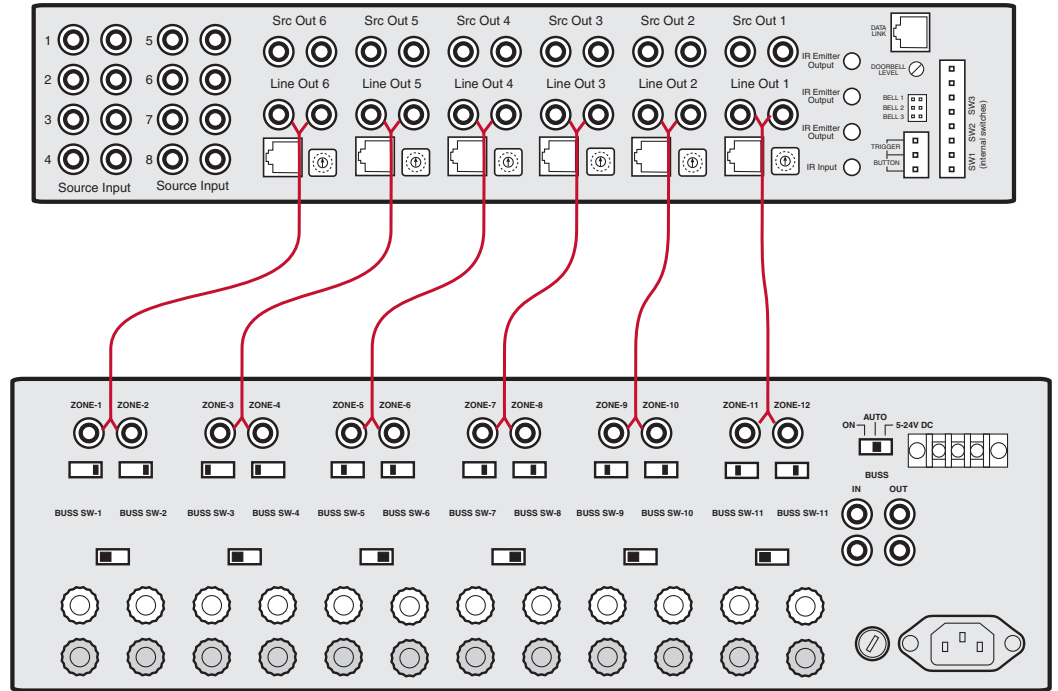

Figure 6: Connecting the A 5030 to the A 5024 with stereo RCA cables.

This configuration is essential for each zone that you wish to use local source inputs on via the A 5036 wallplates. You may use a combination of zones utilising dedicated inputs or common source inputs if required.



Specifications

SYSTEM

Output Level (max)8V RMS
Frequency response	10Hz – 50kHz +/- 0.5dB
Total harmonic Distortion	<0.005% (20Hz – 20kHz)
Hum and Noise	< -80dB
Crosstalk	<-60dB at 1kHz
Input impedance.....	.30k Ohms
Voltage gain10dB

CONTROLLER

Connectors

Audio input	8 x stereo RCA sockets (inc. priority input)
Line output	6 x stereo RCA sockets
Source output	6 x stereo RCA sockets
Wallplate connections	6 x RJ45 8P8C sockets
IR emitters.....	3 x 3.5mm mono sockets
IR receiver	3.5mm stereo socket
Priority switch contact	screw terminal block
Output switch contact.....	screw terminal blocks
AC power	IEC socket
Dimensions	420W x 350D x 88mmH
Input voltage	100/120V ac, 220/240V ac switchable 50/60Hz

Weight	5.8kg
Fuse.....	3A M205 size

WALL PLATE

Indicators:.....	Receive / transmit LED Switched outputs (x3 LED)
Controls:.....	Volume up/down, Source up/down

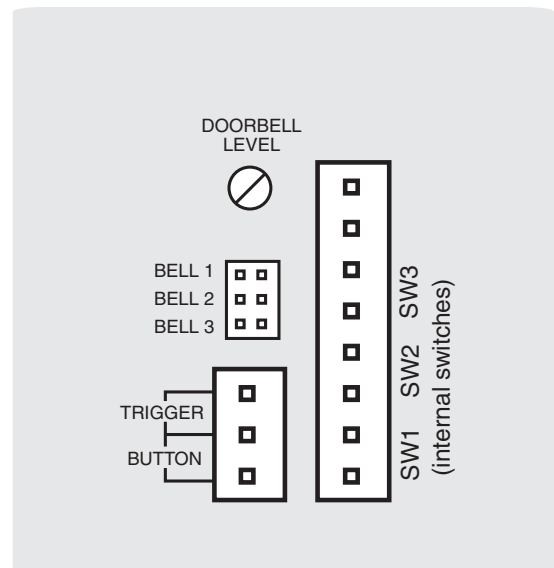

Figure 7: Doorbell terminals & level control.